

PRICE LIST USD

MATCH BY MULLER VAN SEVEREN

INDEX

3	MATCH KITCHEN
9	MATCH BATHROOM
11	MATCH WARDROBE

Kitchen pricing

This is your guide to pricing on the MATCH kitchen by Muller Van Severen. The design is compatible with our own cabinets and IKEA's METOD kitchen. For more information on the design, visit the dedicated MATCH page on reformcph.com

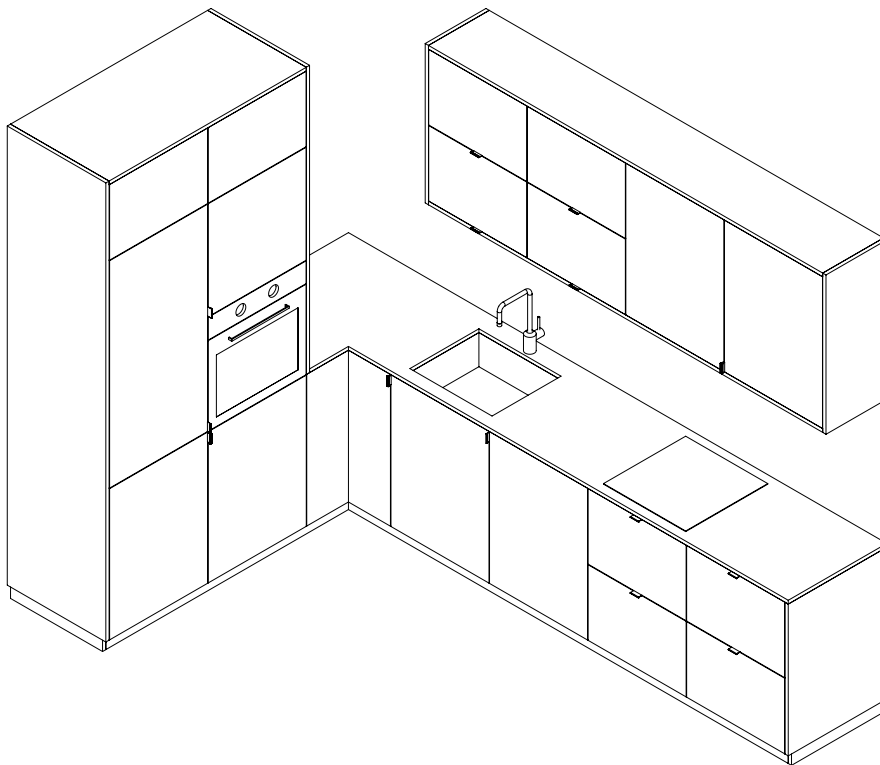

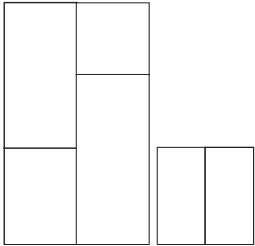

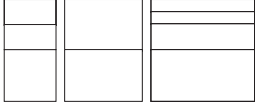
Door	Measurement	HDPE / All colors
	W12 x H30	202 USD
	W12 x H40	252 USD
	W13 x H30 (2 pcs.)	436 USD
	W15 x H15	146 USD
	W15 x H20	176 USD
	W15 x H30	238 USD
	W15 x H40	298 USD
	W15 x H50	360 USD
	W15 x H60	420 USD
	W15 x H80	540 USD
W15 x H90	604 USD	
W18 x H15	166 USD	
W18 x H20	202 USD	
W18 x H30	274 USD	
W18 x H40	346 USD	
W18 x H50	420 USD	
W18 x H60	492 USD	
W18 x H80	640 USD	
W18 x H90	712 USD	
W21 x H20	224 USD	
W21 x H30	310 USD	
W21 x H40	396 USD	
W24 x H20	252 USD	
W24 x H30	346 USD	
W24 x H40	446 USD	
W24 x H50	540 USD	
W24 x H60	640 USD	
W24 x H80	834 USD	
W24 x H90	932 USD	

Drawer front	Measurement	HDPE / All colors
	W12 x H30	188 USD
	W15 x H10	104 USD
	W15 x H15	136 USD
	W15 x H20	166 USD
	W15 x H30	224 USD
	W15 x H5	94 USD
	W18 x H10	116 USD
	W18 x H15	152 USD
	W18 x H20	188 USD
	W18 x H30	262 USD
	W18 x H5	104 USD
	W21 H10	130 USD
	W21 H15	172 USD
	W21 H30	300 USD
	W21 H5	112 USD
	W24 x H10	140 USD
	W24 x H15	188 USD
	W24 x H20	238 USD
	W24 x H30	336 USD
	W24 x H5	122 USD
	W30 x H10	166 USD
	W30 x H15	224 USD
	W30 x H30	410 USD
	W30 x H5	140 USD
	W36 x H10	188 USD
	W36 x H15	262 USD
	W36 x H5	158 USD

Pull out front	Measurement	HDPE / All colors
	W12 x H15	130 USD
	W12 x H30	202 USD
	<hr/>	
	W15 x H15	146 USD
	W15 x H30	238 USD
	<hr/>	
	W18 x H20	202 USD
	W18 x H30	274 USD
	W18 x H30	274 USD
	W18 x H40	346 USD
W18 x H50	420 USD	
W18 x H60	492 USD	
W18 x H80	640 USD	
W18 x H90	712 USD	

Top-hinged front	Measurement	HDPE / All colors
	W24 x H15	202 USD
	W30 x H15	238 USD
	W36 x H15	274 USD

Side panel	Measurement	HDPE / All colors
	W15 9/16 x H15	122 USD
	W15 9/16 x H15 7/9	126 USD
	W15 9/16 x H16 4/7	130 USD
	W15 9/16 x H20	142 USD
	W15 9/16 x H20 7/9	146 USD
	W15 9/16 x H21	150 USD
	W15 9/16 x H21 4/7	150 USD
	W15 9/16 x H30	188 USD
	W15 9/16 x H30 7/9	192 USD
	W15 9/16 x H31 4/7	196 USD
	W15 9/16 x H35	208 USD
	W15 9/16 x H36	214 USD
	W15 9/16 x H40	232 USD
	W15 9/16 x H40 7/9	234 USD
	W15 9/16 x H41 4/7	238 USD
	W15 9/16 x H65	340 USD
	W15 9/16 x H80	406 USD
	W15 9/16 x H86	432 USD
	W15 9/16 x H90	448 USD
	W15 9/16 x H96	474 USD
	W24 13/16 x H15	162 USD
	W24 13/16 x H20	196 USD
	W24 13/16 x H21	202 USD
	W24 13/16 x H30	264 USD
	W24 13/16 x H36	308 USD
	W24 13/16 x H65	508 USD
	W24 13/16 x H80	614 USD
	W24 13/16 x H86	656 USD
	W24 13/16 x H90	682 USD
	W24 13/16 x H96	726 USD
	W36 x H96	1,024 USD
	W40 1/5 x H30	396 USD
	W40 1/5 x H30 7/9	402 USD
	W40 1/5 x H35 4/9	456 USD
	W49 x H30	468 USD
	W49 x H30 7/9	478 USD
	W49 x H35 4/9	544 USD

Insert	Measurement	HDPE / All colors
	W24 x H15	156 USD
	W24 x H6	110 USD
	<hr/>	
	W30 x H15	182 USD
	W30 x H6	122 USD
	<hr/>	
	W36 x H15	208 USD
	W36 x H6	136 USD
	<hr/>	
	W8 x H30	122 USD

Plinth	Measurement	HDPE / All colors
	W87 x H4.5	168 USD
	W87 x H6	180 USD

Bathroom pricing

This is your guide to pricing on MATCH Bathroom by Muller Van Severen. The design is compatible with our own cabinets and IKEA's GODMORGON products.

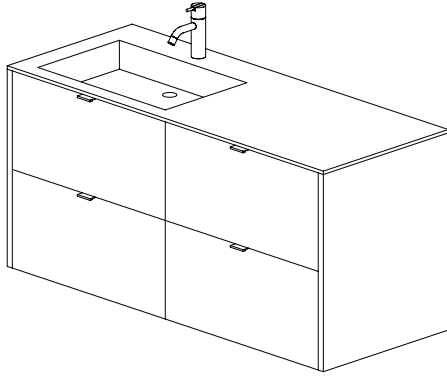

Door	Measurement	HDPE / All colors
	W15 5/8 x H75 1/2	538 USD
	W15 5/8 x H22 3/4	202 USD
	W15 5/8 x H37 5/7	298 USD

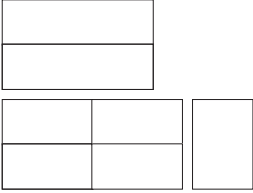
Drawer front	Measurement	HDPE / All colors
	W39 1/4 x H11 1/5	224 USD
	W15 5/8 x H11 1/5	116 USD
	W15 5/8 x H22 3/5	188 USD
	W23 1/2 x H11 1/5	152 USD
	W27 4/9 x H11 1/5	168 USD
	W31 3/8 x H11 1/5	188 USD

Side panel	Measurement	HDPE / All colors
	W5 1/2 x H37 7/9	140 USD
	W12 3/5 x H75 3/5	324 USD
	W12 3/5 x H22 5/6	136 USD
	W18 1/2 x H22 5/6	176 USD

Wardrobe pricing

This is your guide to pricing on MATCH Wardrobe by Muller Van Severen. The design is compatible with our own cabinets and IKEA's PAX wardrobe system.

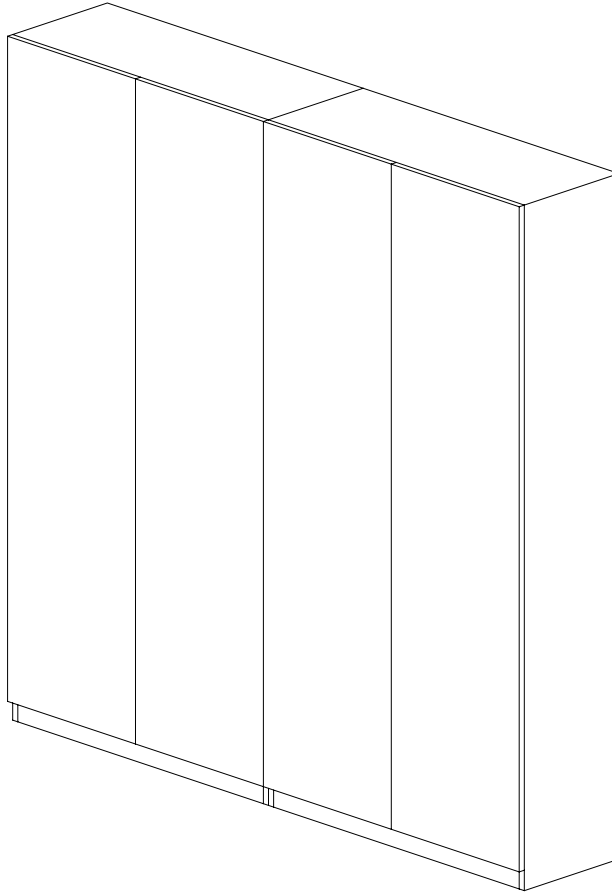

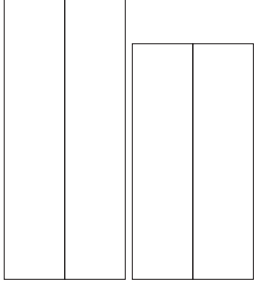
Door	Measurement	HDPE / All colors
	W9 2/3 H76 5/8	364 USD
	W9 2/3 H90 1/2	420 USD
	W9 2/3 H78 2/3 (to floor)	372 USD
	W9 2/3 H92 1/2 (to floor)	428 USD
	<hr/>	
	W14 4/7 H76 5/8	512 USD
	W14 4/7 H90 1/2	594 USD
	W14 4/7 H78 2/3 (to floor)	524 USD
	W14 4/7 H92 1/2 (to floor)	606 USD
	<hr/>	
	W19 1/2 H76 5/8	666 USD
	W19 1/2 H90 1/2	774 USD
W19 1/2 H78 2/3 (to floor)	682 USD	
W19 1/2 H92 1/2 (to floor)	790 USD	

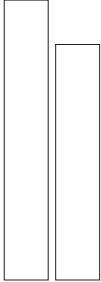
Side panel	Measurement	HDPE / All colors
	W14 3/4 x H76 5/8	372 USD
	W14 3/4 x H79 2/9	382 USD
	W14 3/4 x H90 1/2	432 USD
	W14 3/4 x H93	442 USD
	<hr/>	
	W23 5/8 x H76 5/8	564 USD
	W23 5/8 x H79 2/9	580 USD
	W23 5/8 x H90 1/2	656 USD
	W23 5/8 x H93	672 USD

Insert	Measurement	HDPE / All colors
	W6 x H76 5/8	224 USD
	W6 x H79 2/9	232 USD
	W6 x H90 1/2	254 USD
	W6 x H93	262 USD